

SYSTEM INTERCONNECT

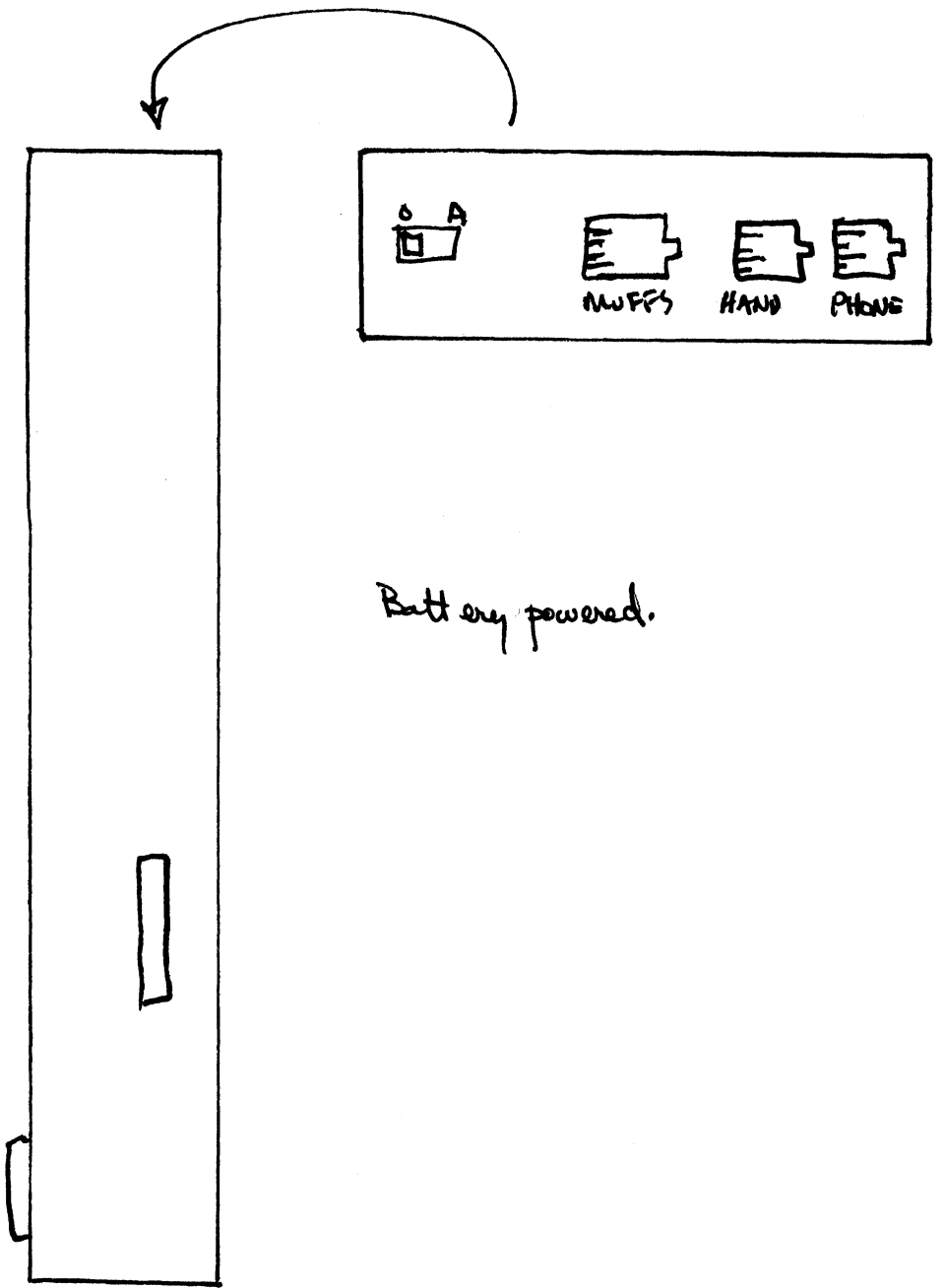

MODEM

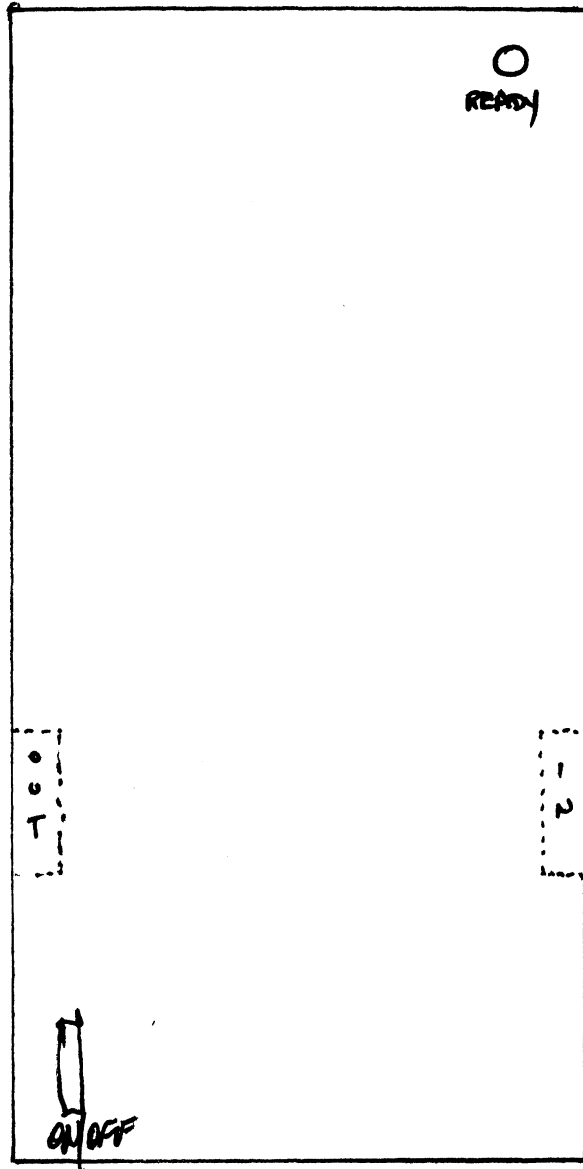
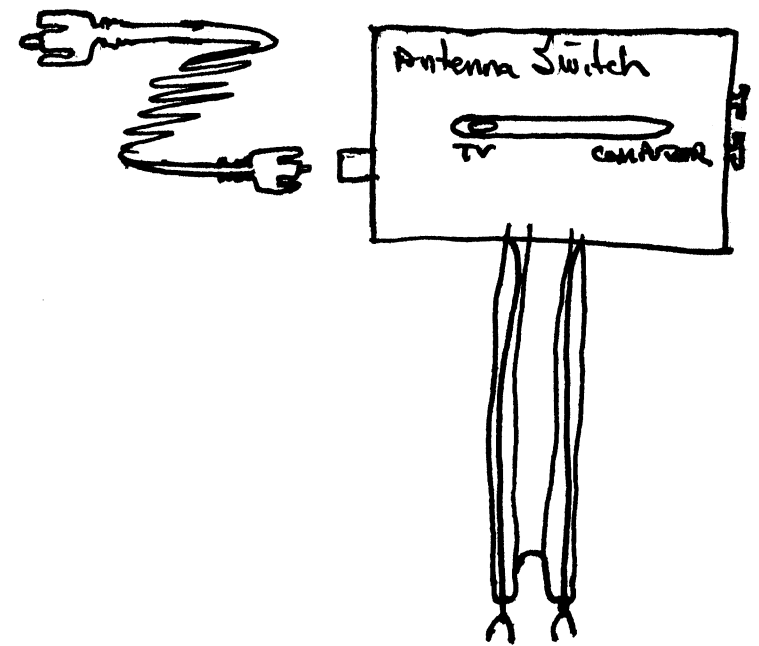
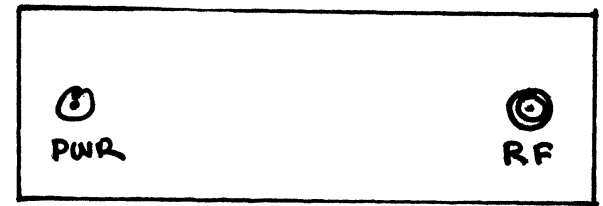
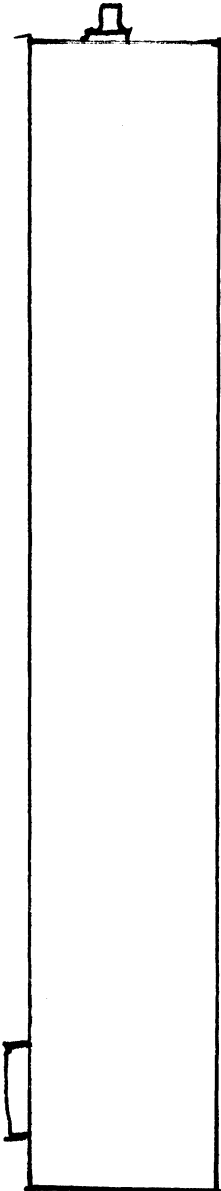
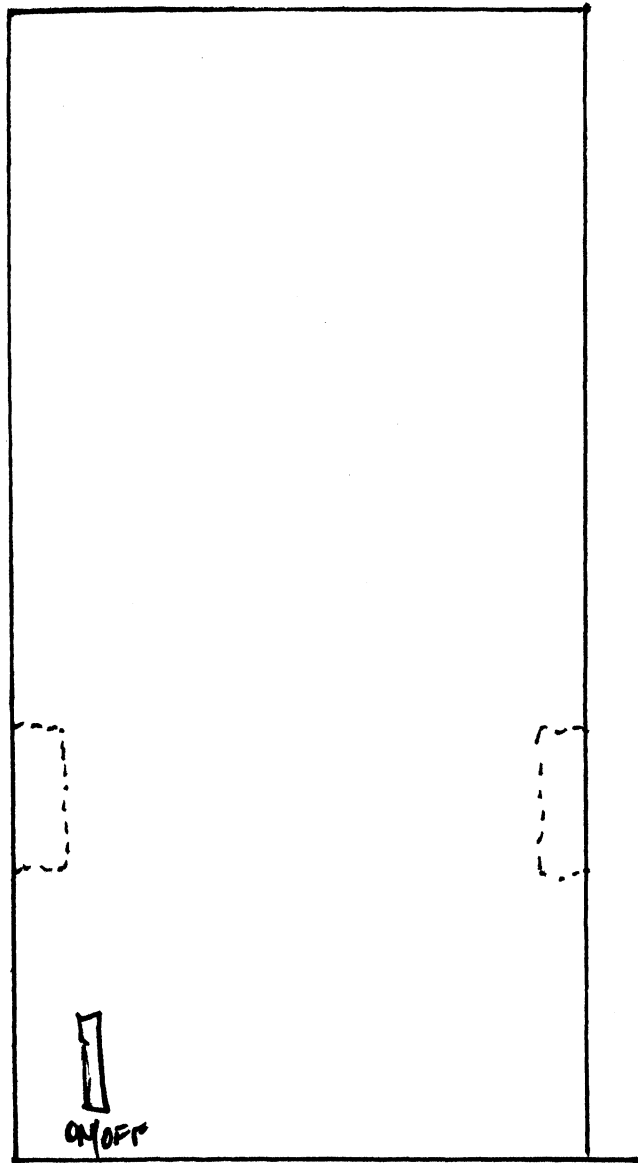

TV INTERFACE

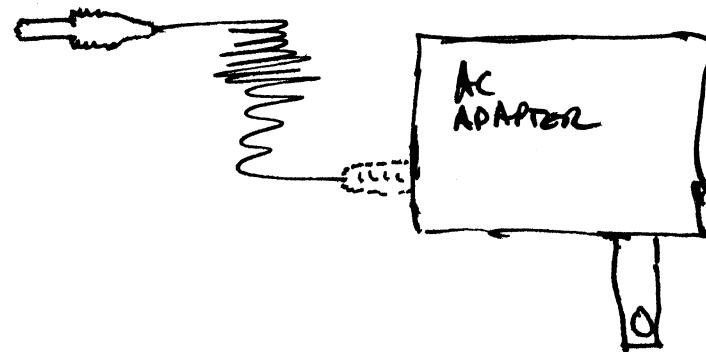
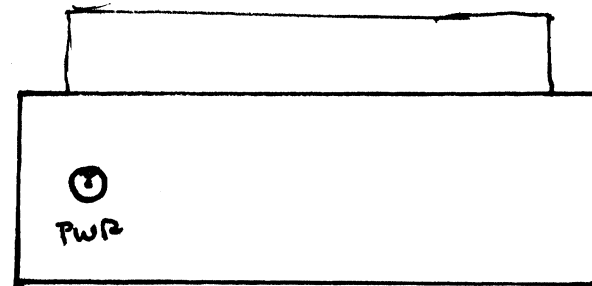
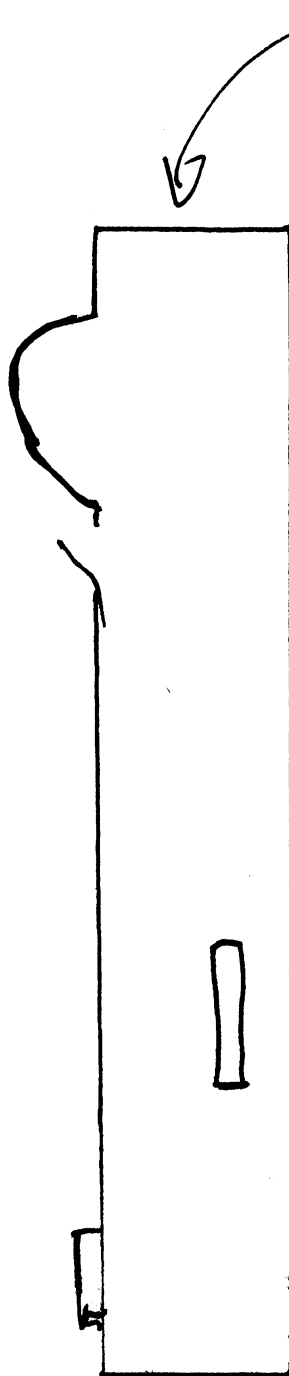
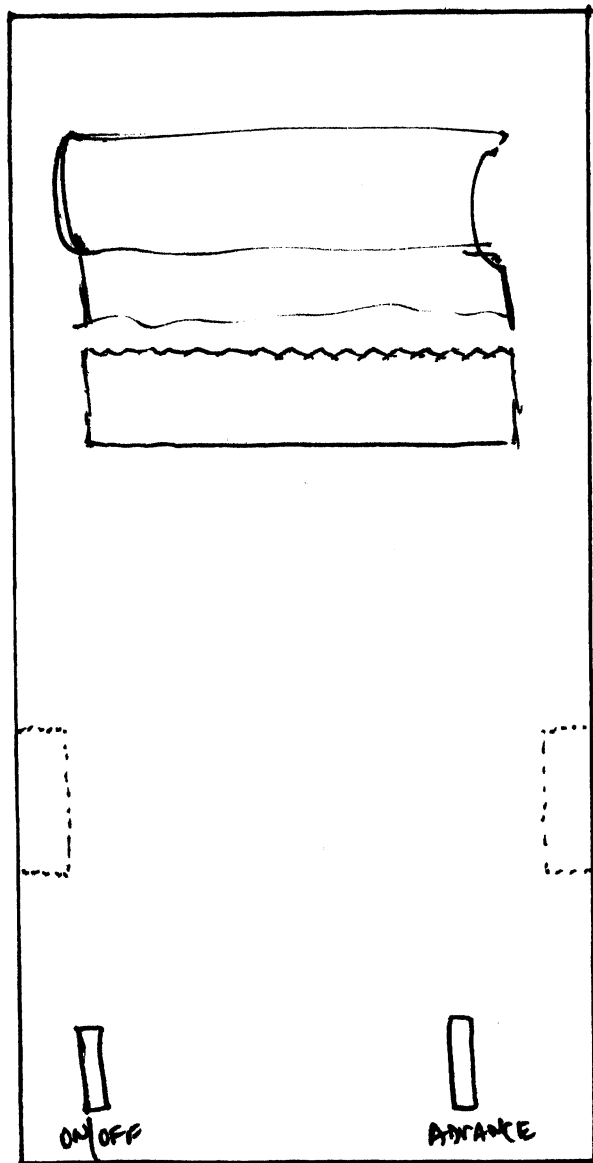

Product may have NICADs, then  
adapter is also charger.

PRINTER

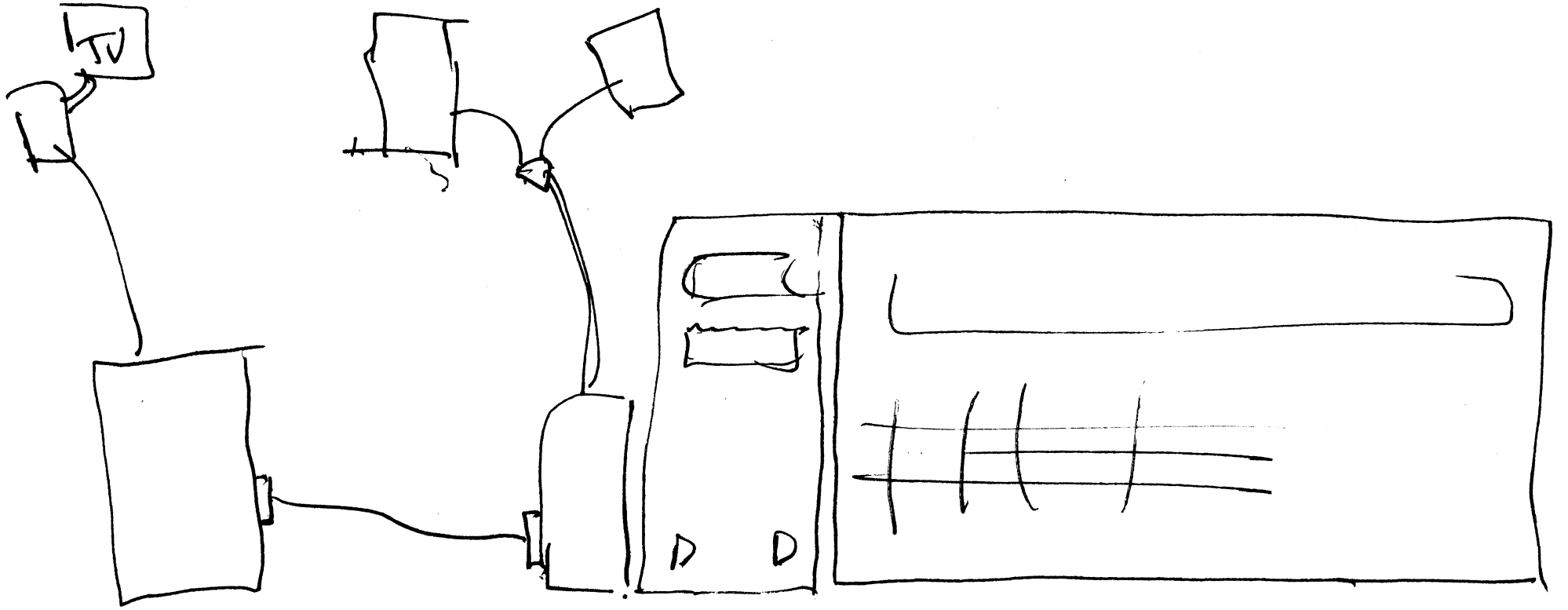

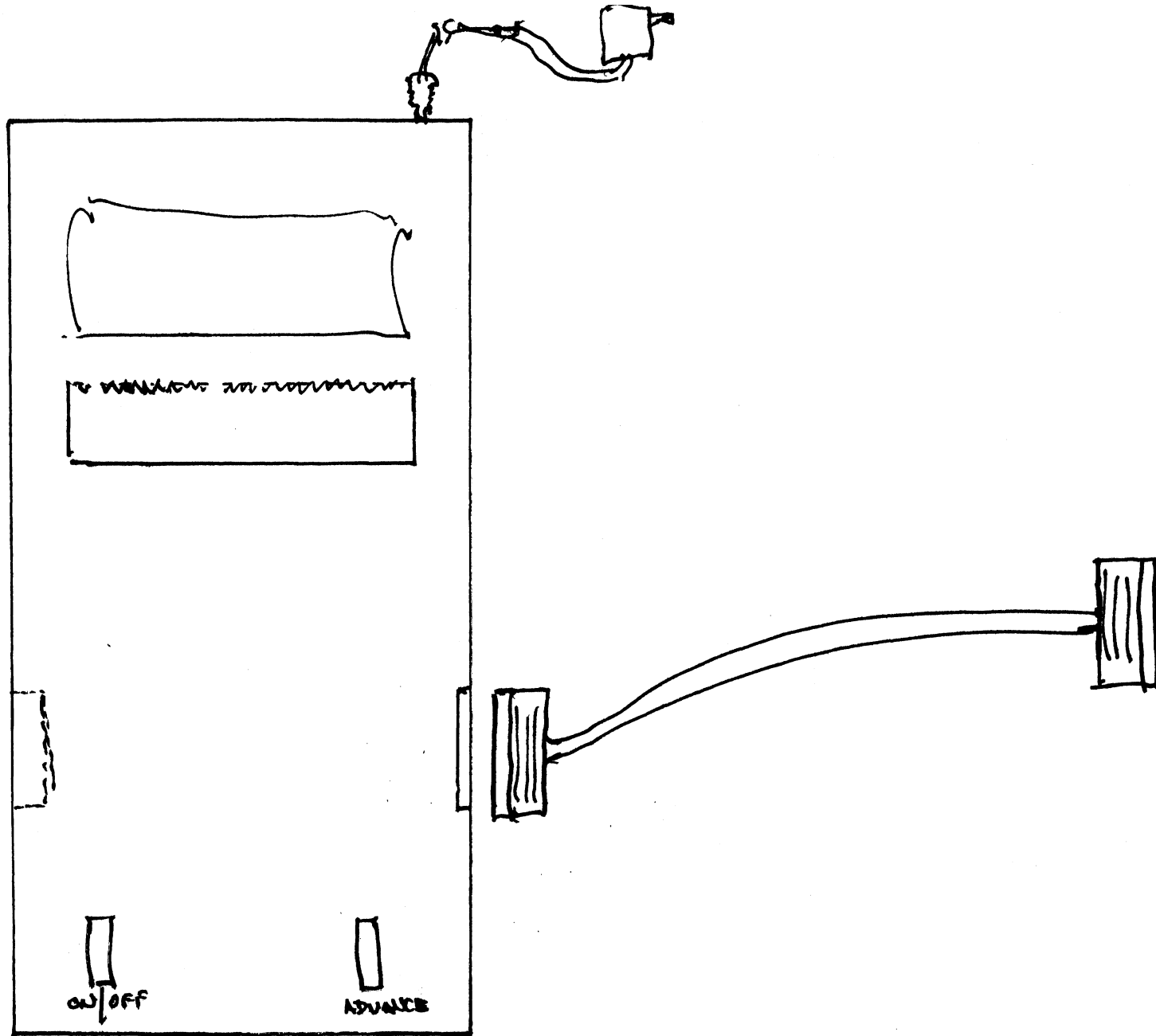

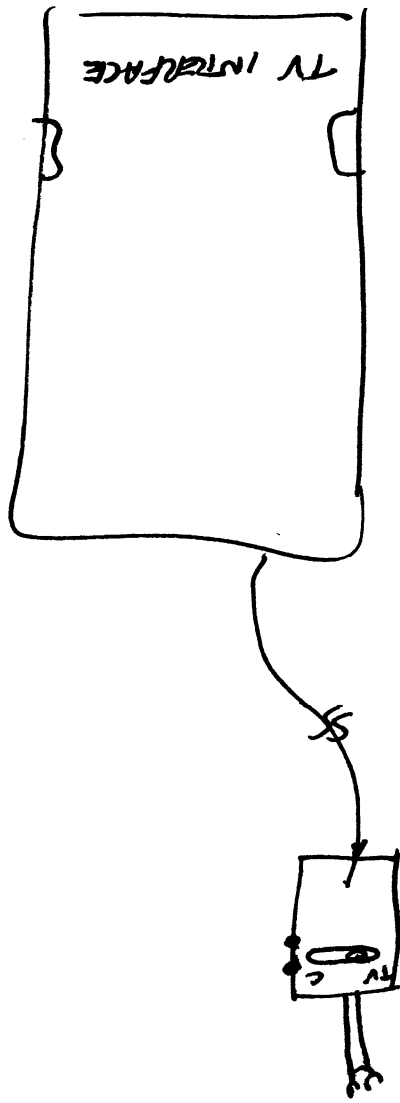



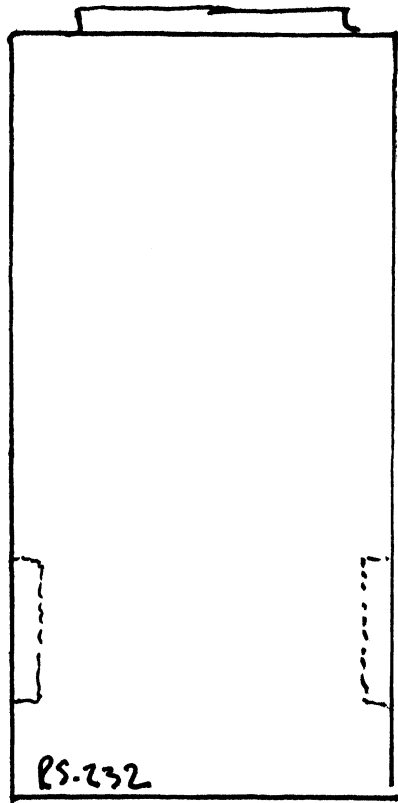
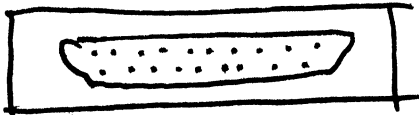

RS-232

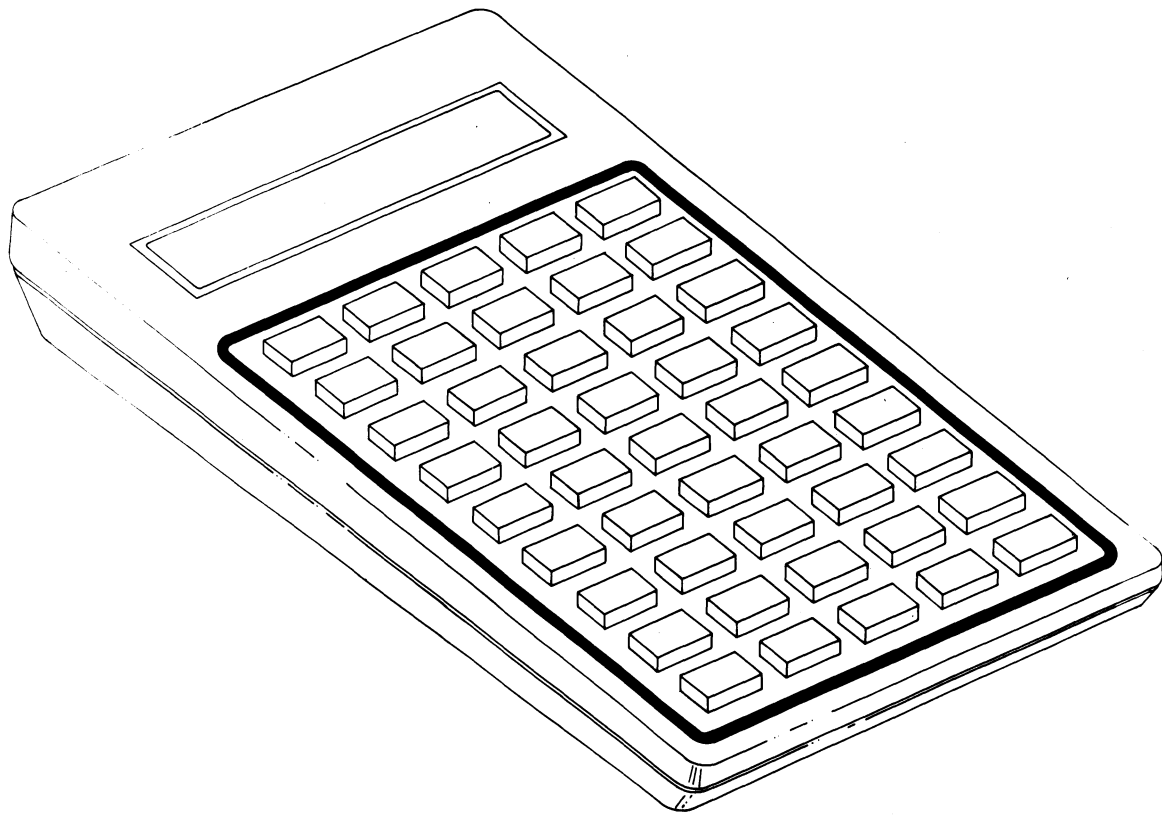

AVG. YIELD=12.4%

A'	B'	C'	D'	E'							
A	B	C	D	E							
2nd	F	INV	G	log	CP	H	Inx	I	CE	J	CLR
Pgm	P → R	sin	cos	tan							
ALPHA	J	x <sup>≥t</sup>	K	x <sup>2</sup>	L	√x	M	1/x			
Ins	CMs	Exc	Prd	Ind							
SST	N	STO	O	RCL	P	SUM	Q	y <sup>x</sup>			
Del	Eng	Fix	Int	(X)							
BST	R	EE	S	(	T	)	U	÷			
Pause	x <sup>-t</sup>	Nop	Op	Deg							
GTO	W	7	X	8	Y	9	Z	X			
Lbl	x <sup>≥t</sup>	Σ+	π	Rad							
SBR	4	5	6	-							
St fig	if fig	D.MS	π	Grad							
RST	1	2	3	+							
Write	Dsz	Adv	Prt	List							
R/S	0	•	+/-	=							

TOTAL MATERIAL COST= 212.53

OFF	ON	↓	↑	:	;	<	>	MODE	2ND	←	→	CL	
I	@	#	\$	%	^	&	?		7	8	9	/	
Q	W	E	R	T	Y	U	I	O	P	4	5	6	*
A	S	D	F	G	H	J	K	L	=	1	2	3	-
SHIFT	Z	X	C	V	B	N	M	SPC	ENTER	0		EXP	+

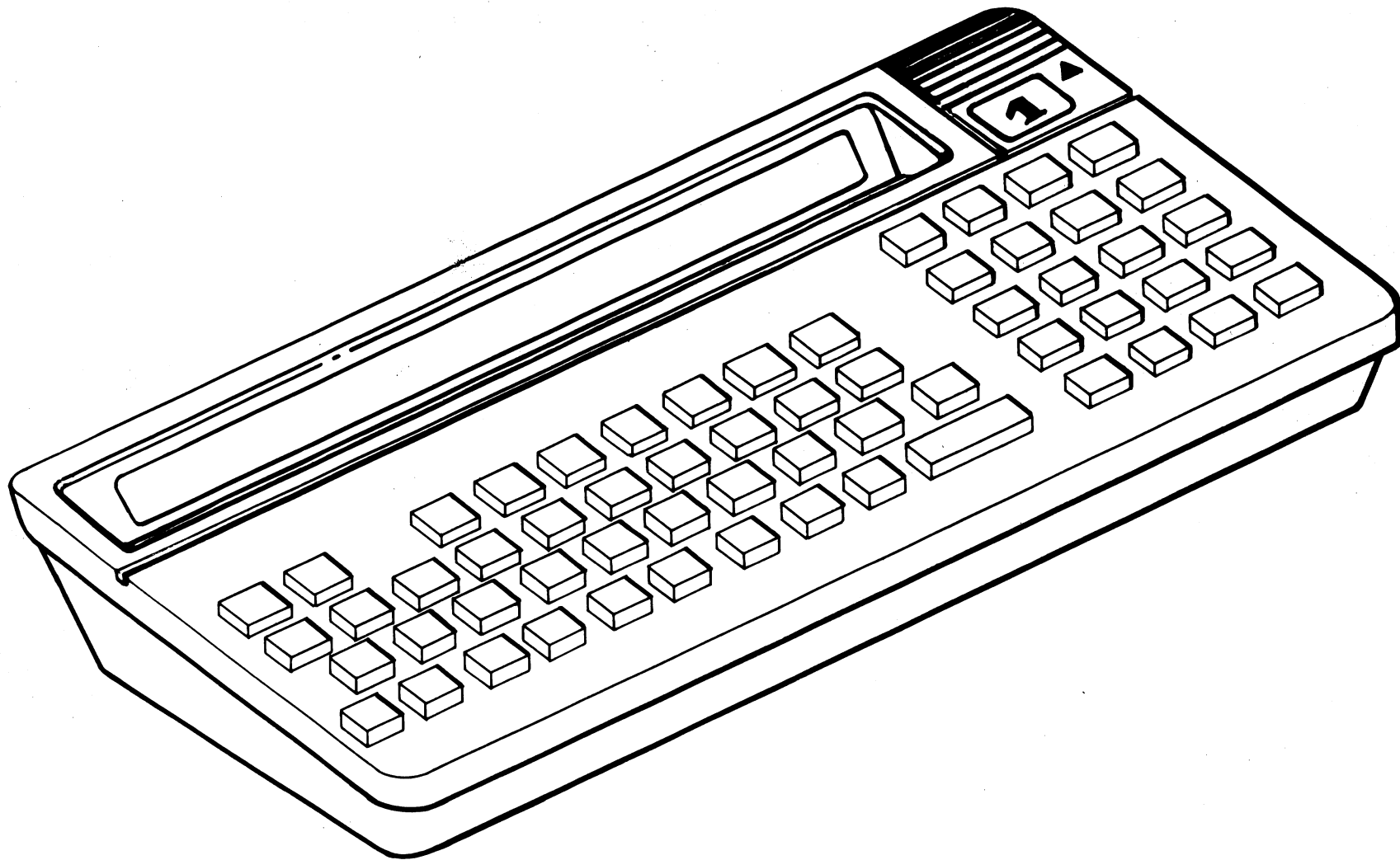

PAYMENT NO. 12= \$ 384.38  
INTEREST = \$ 221.15

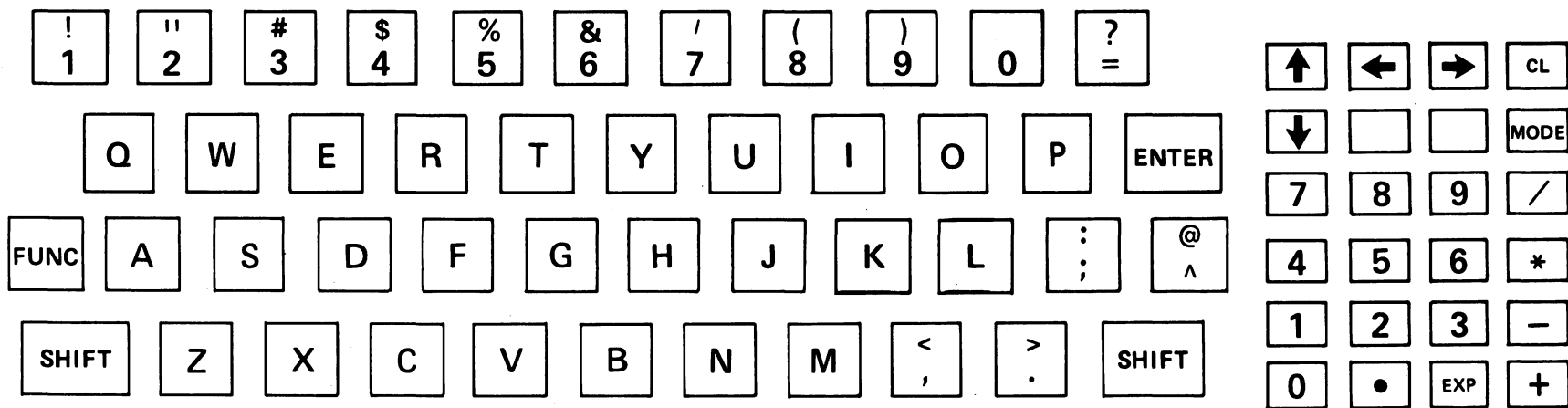

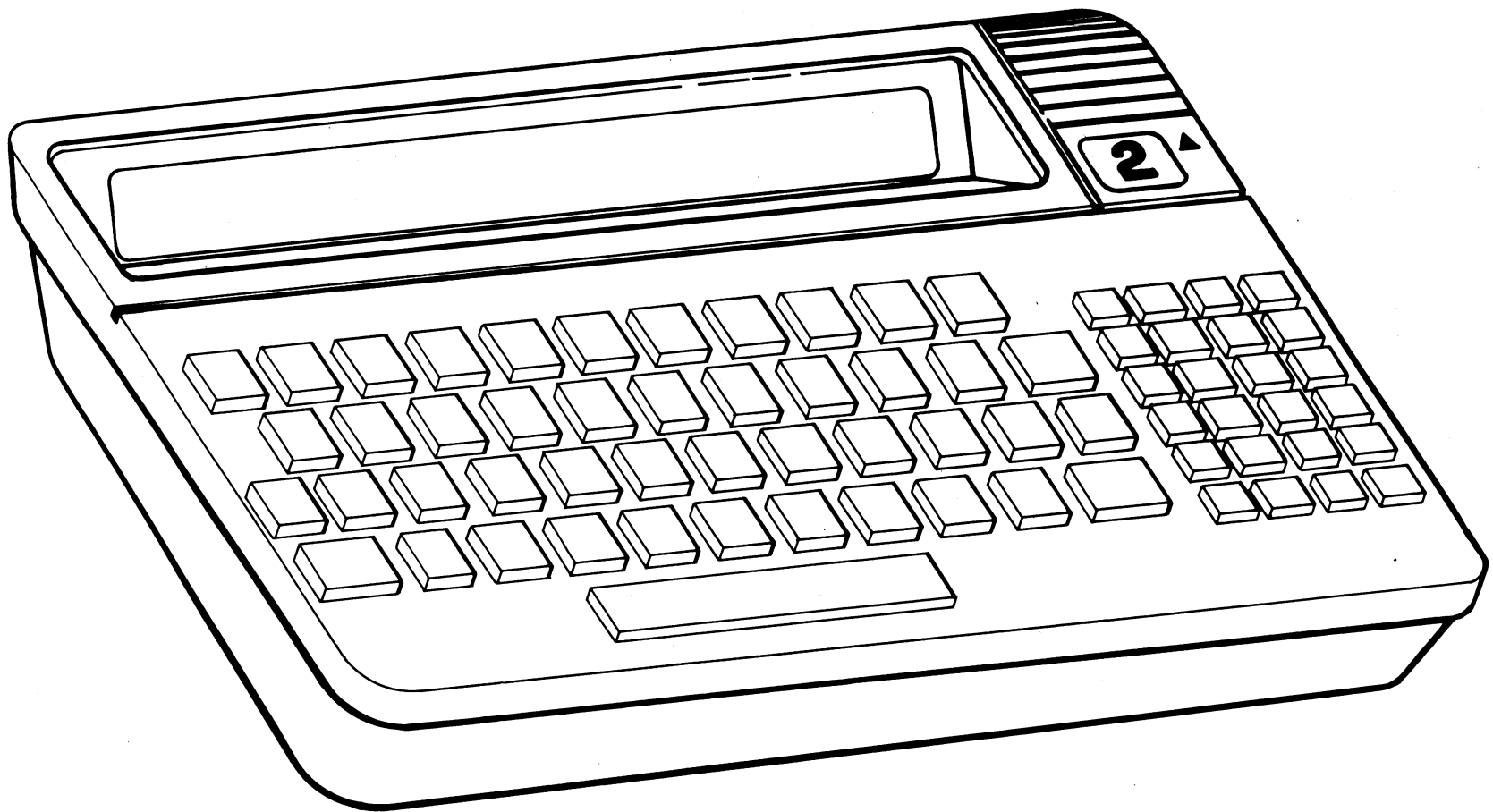

MONTH	JAN	FEB	MAR	1Q	2Q	YEAR
SALES	93.6	100.2	107.2	301	369	1485
MATL	51.1	49.3	53.2	154	180	730
OTHER	46.2	44.1	40.4	131	130	480
PROFIT	-3.7	6.8	13.6	17	59	275
% PROF	-4.0	6.8	12.7	5.5	16.0	18.5

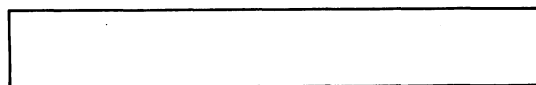
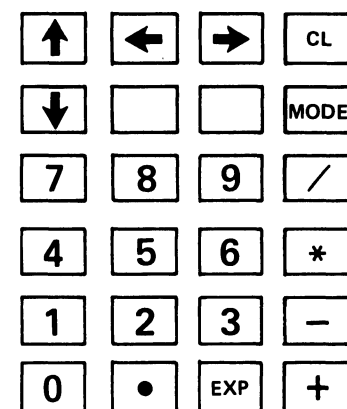
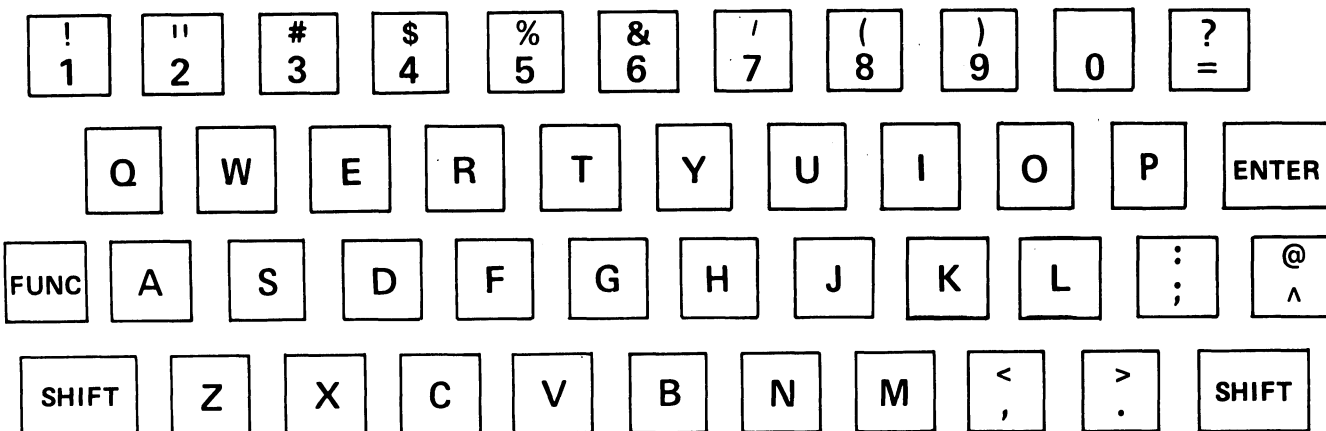



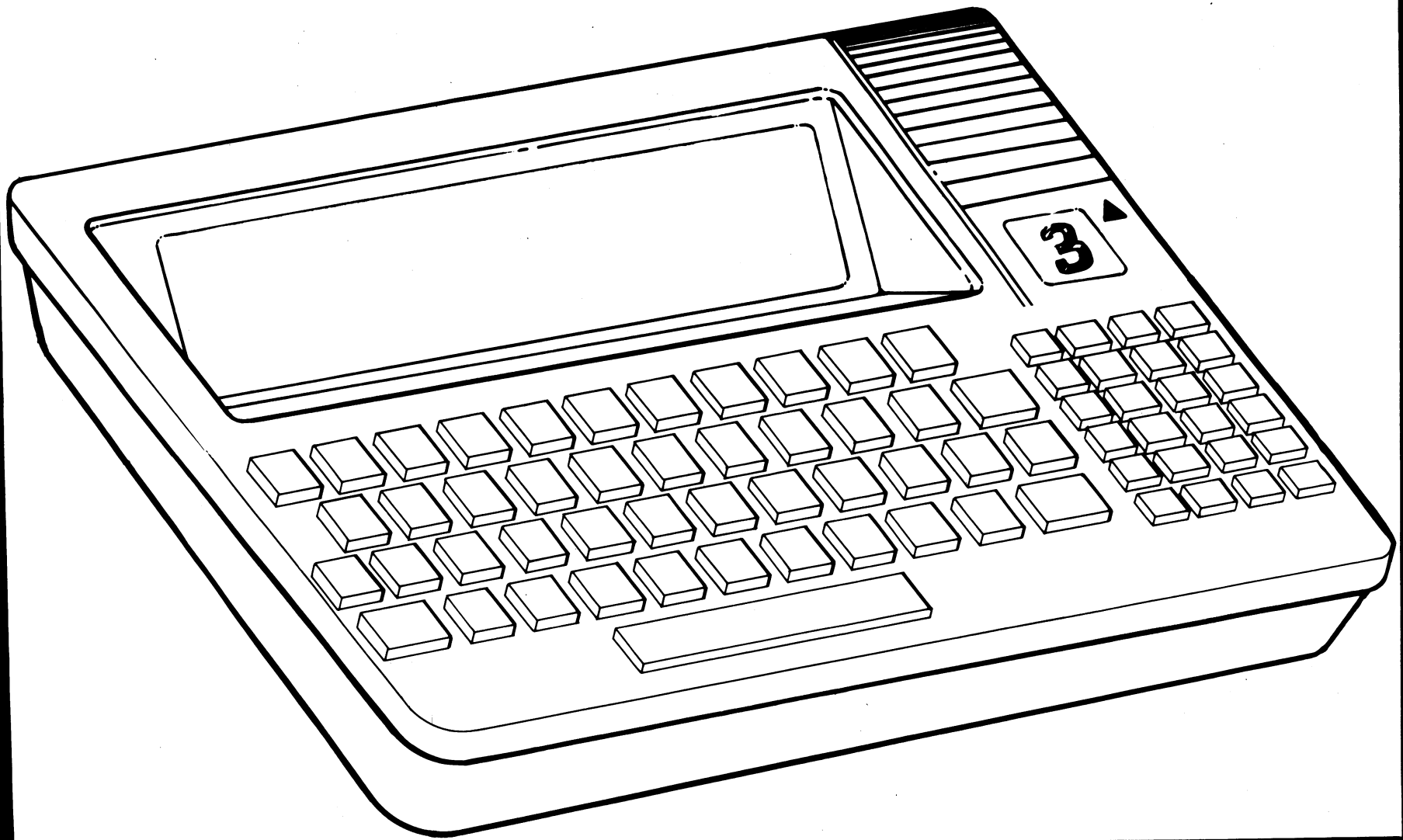

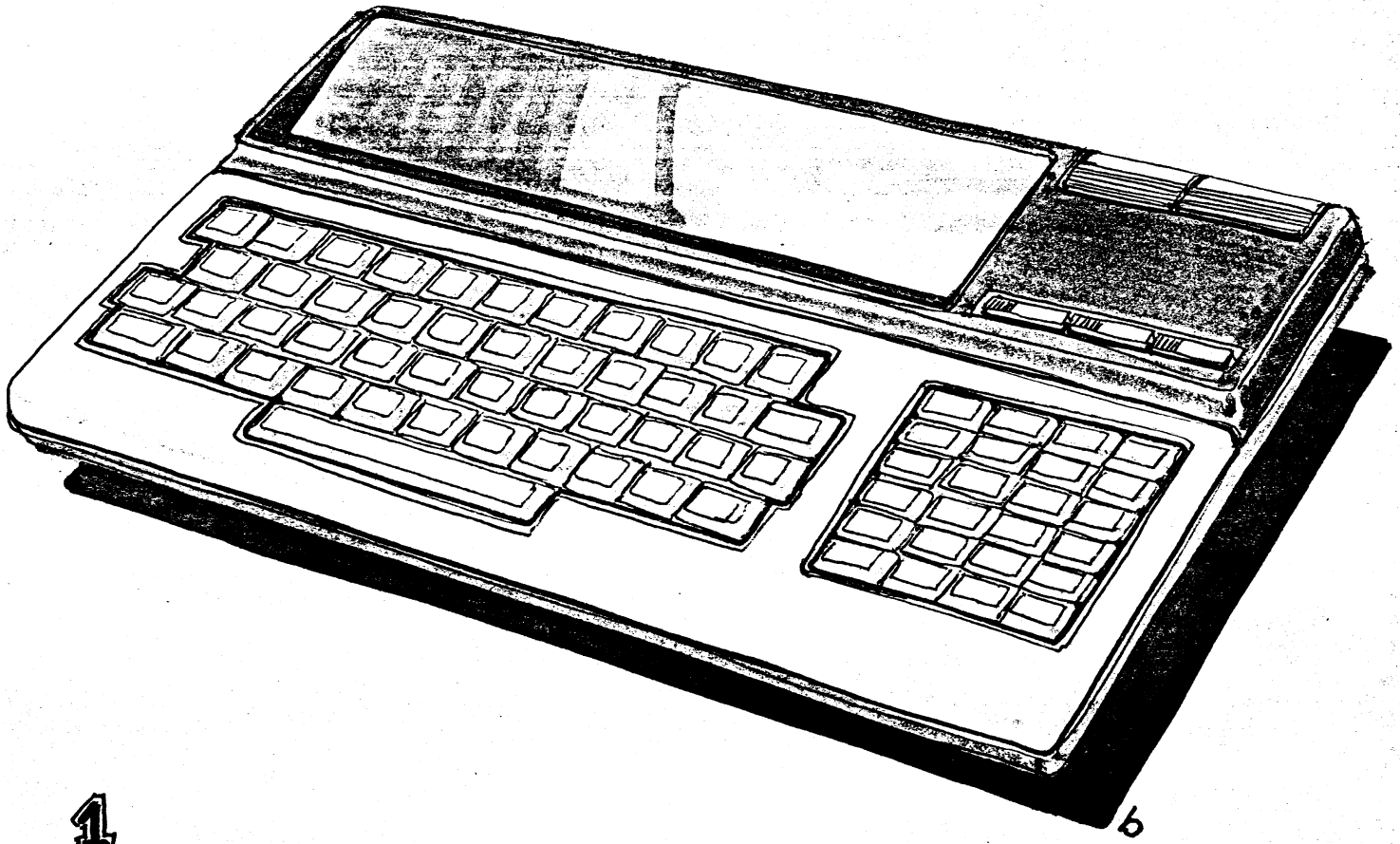
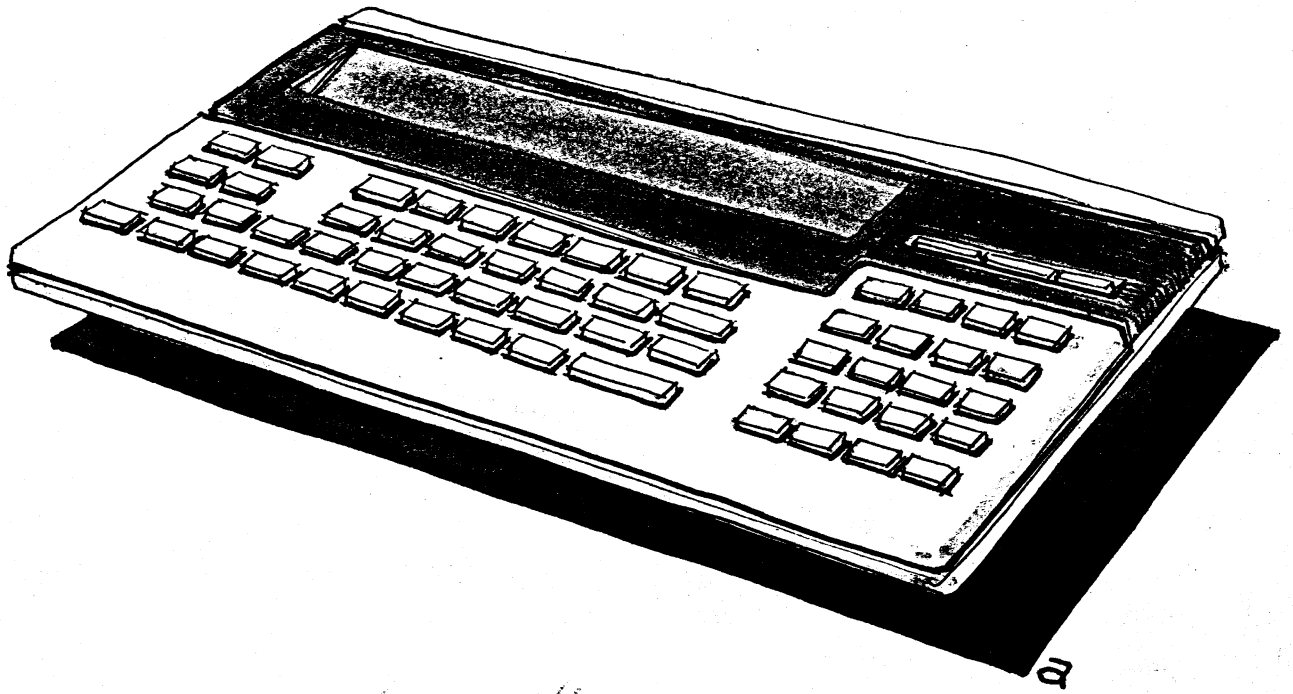

1

*W. Colewell 3/2/81*

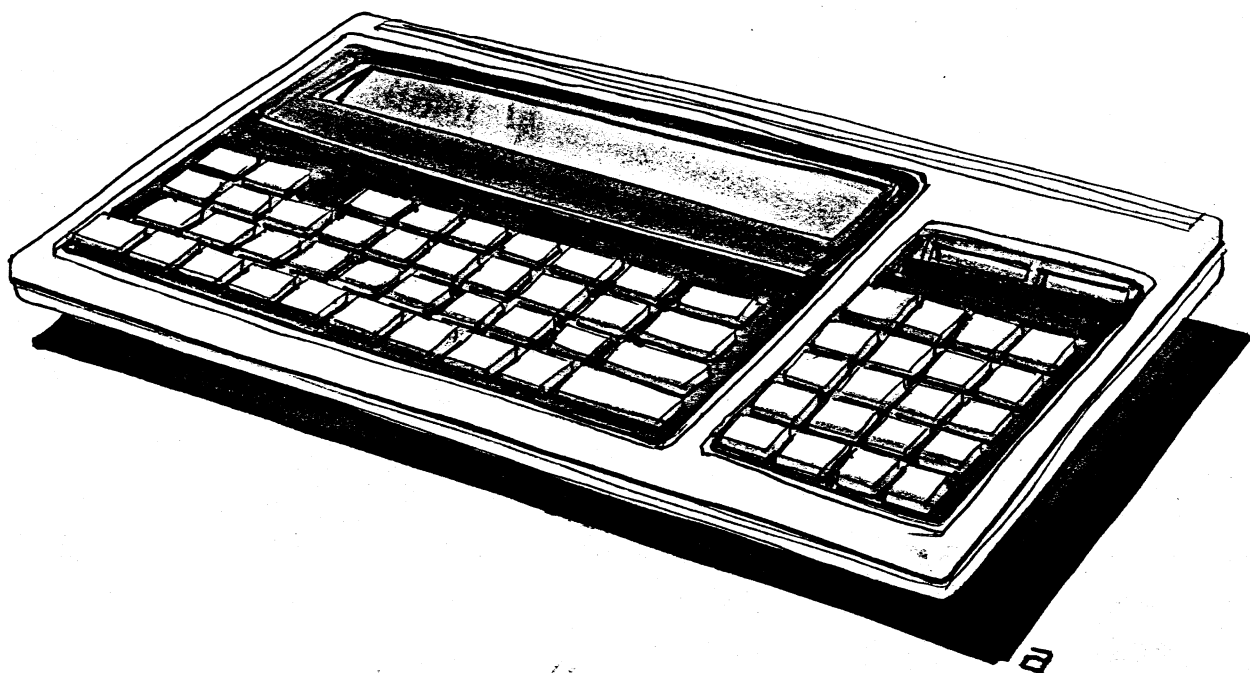

1

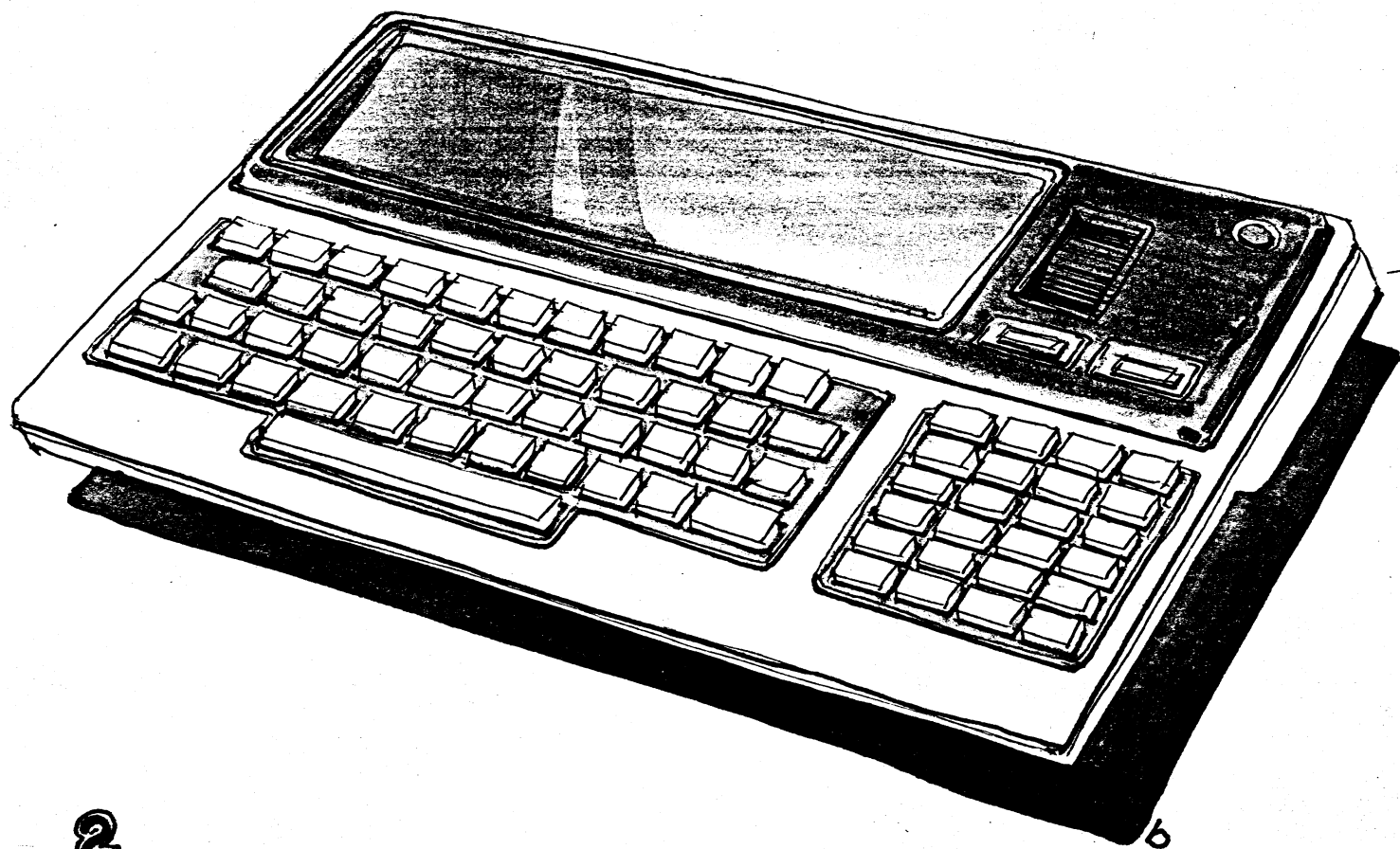

b

2

*Handwritten signature or text*

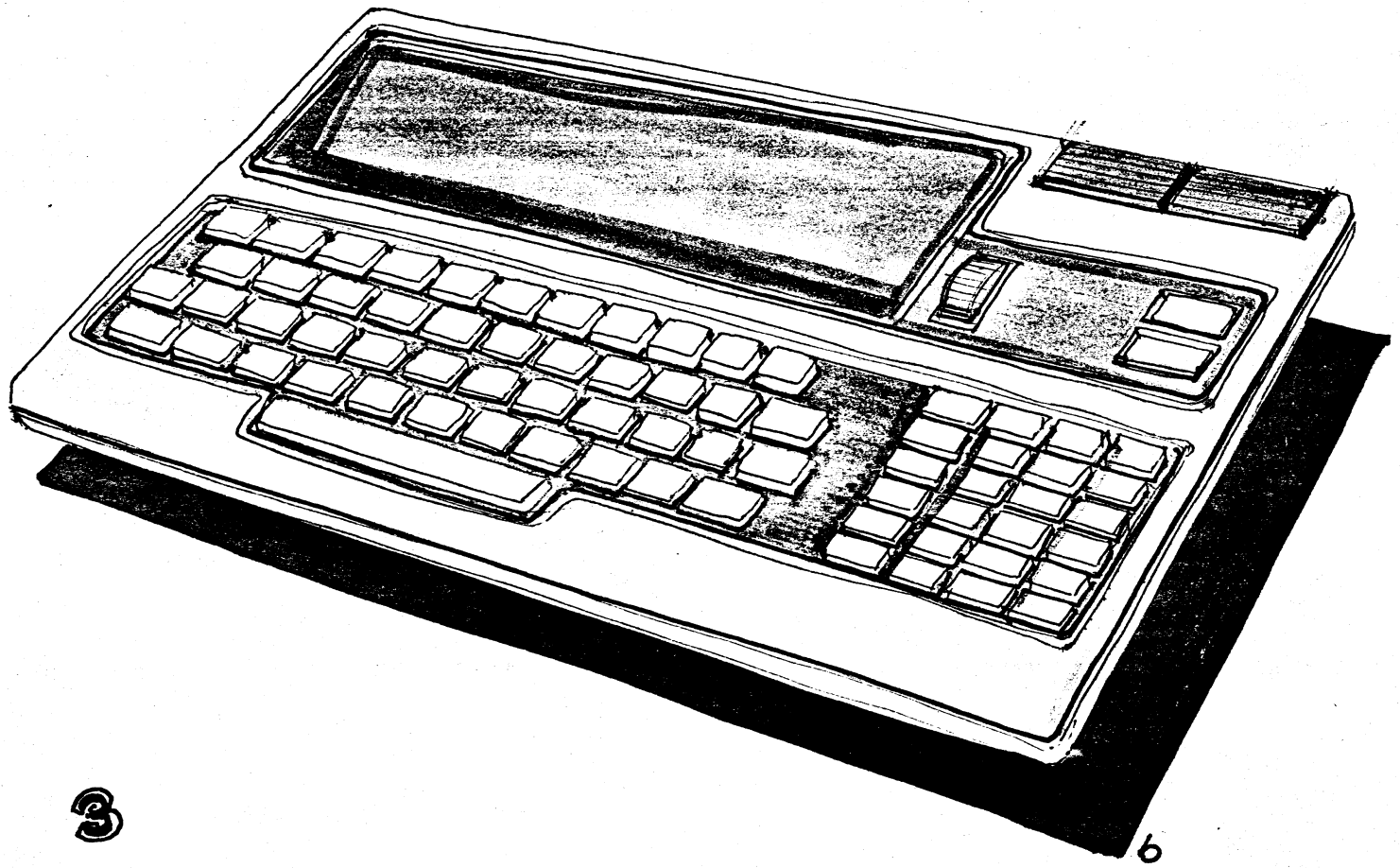
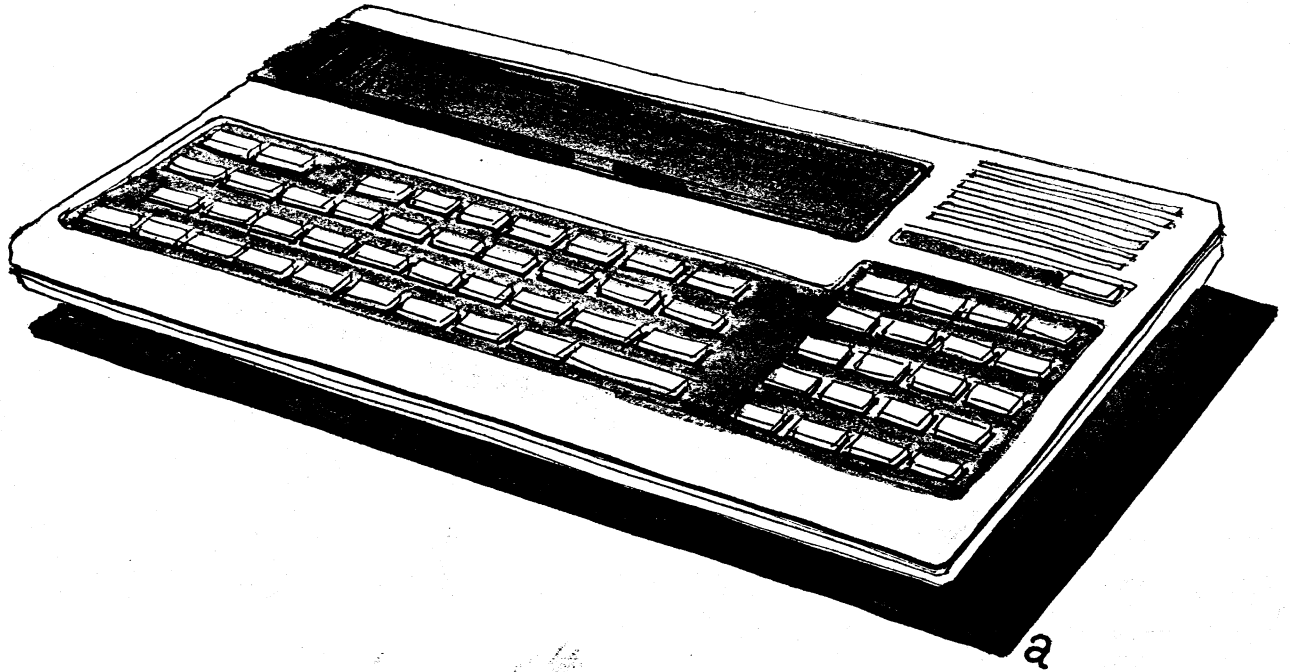

3

*W. O. ... 3/2/81*

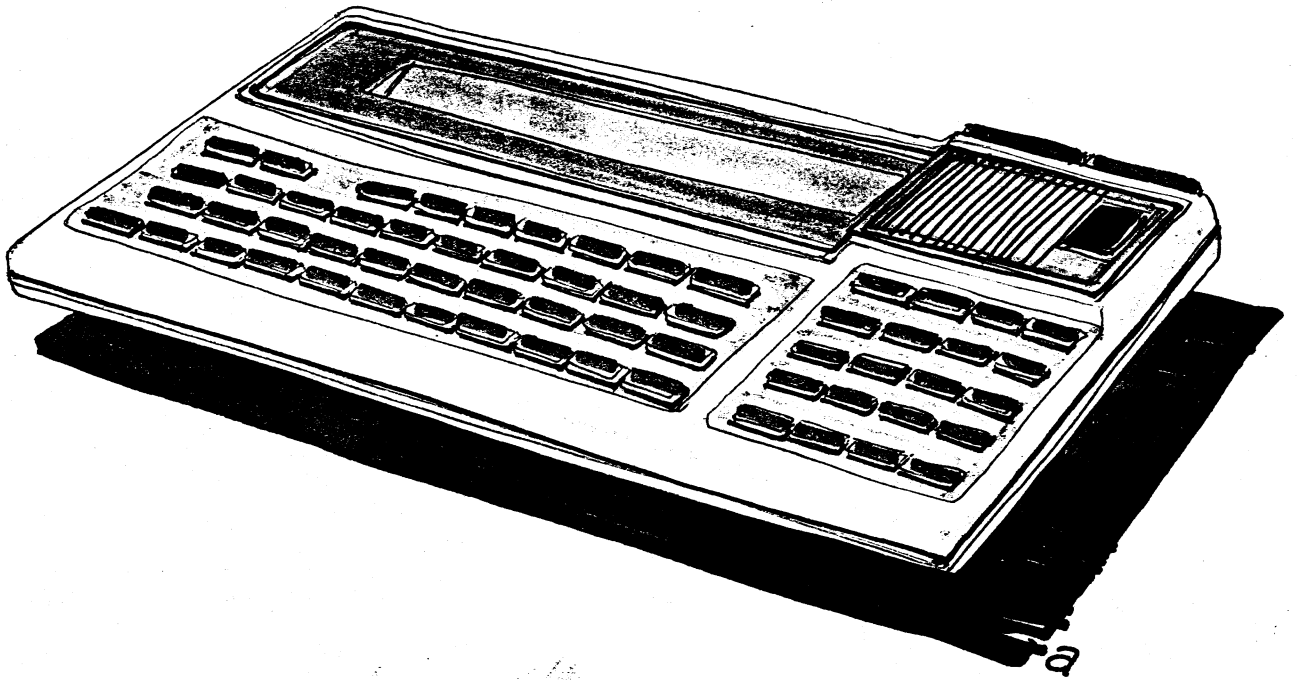

a

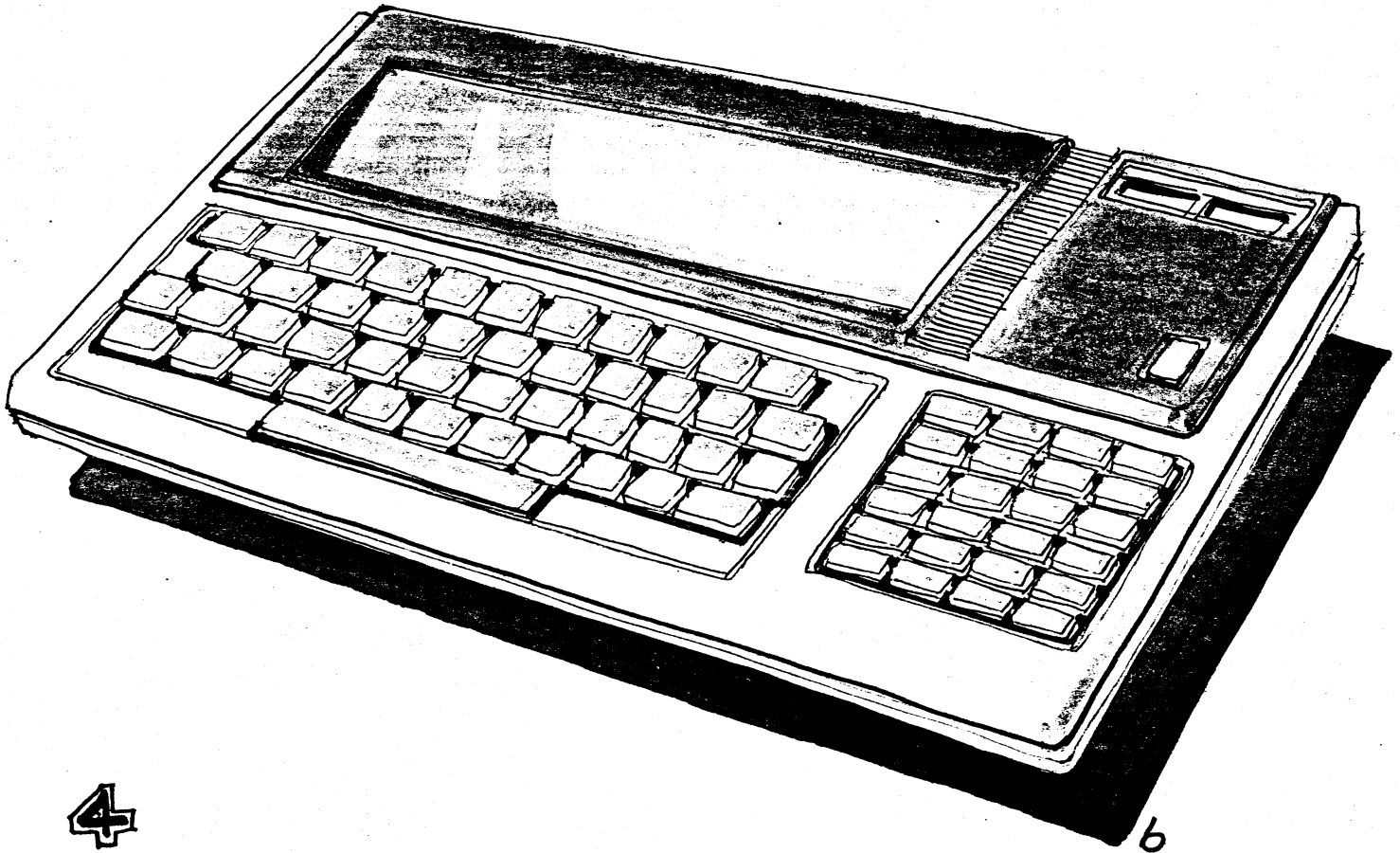

b

4

*Bill Carroll 3/21/81*



5



5

6

*Handwritten signature and date: 3/21/81*

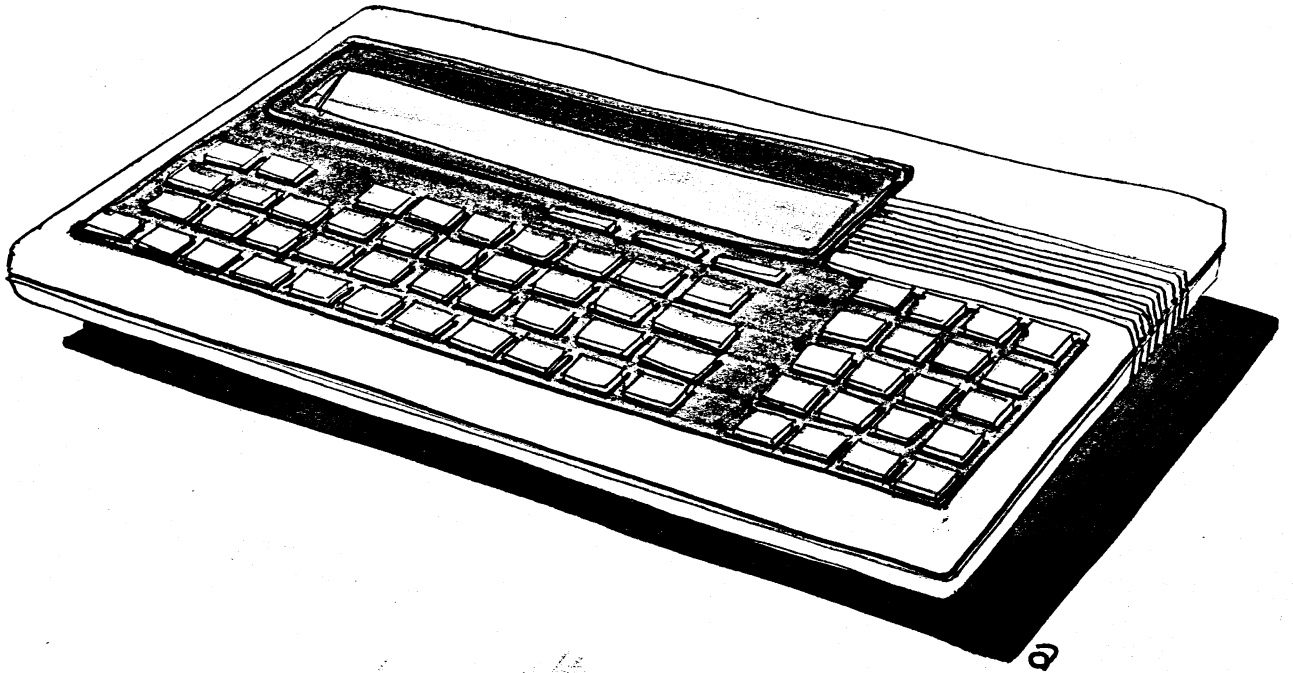

a

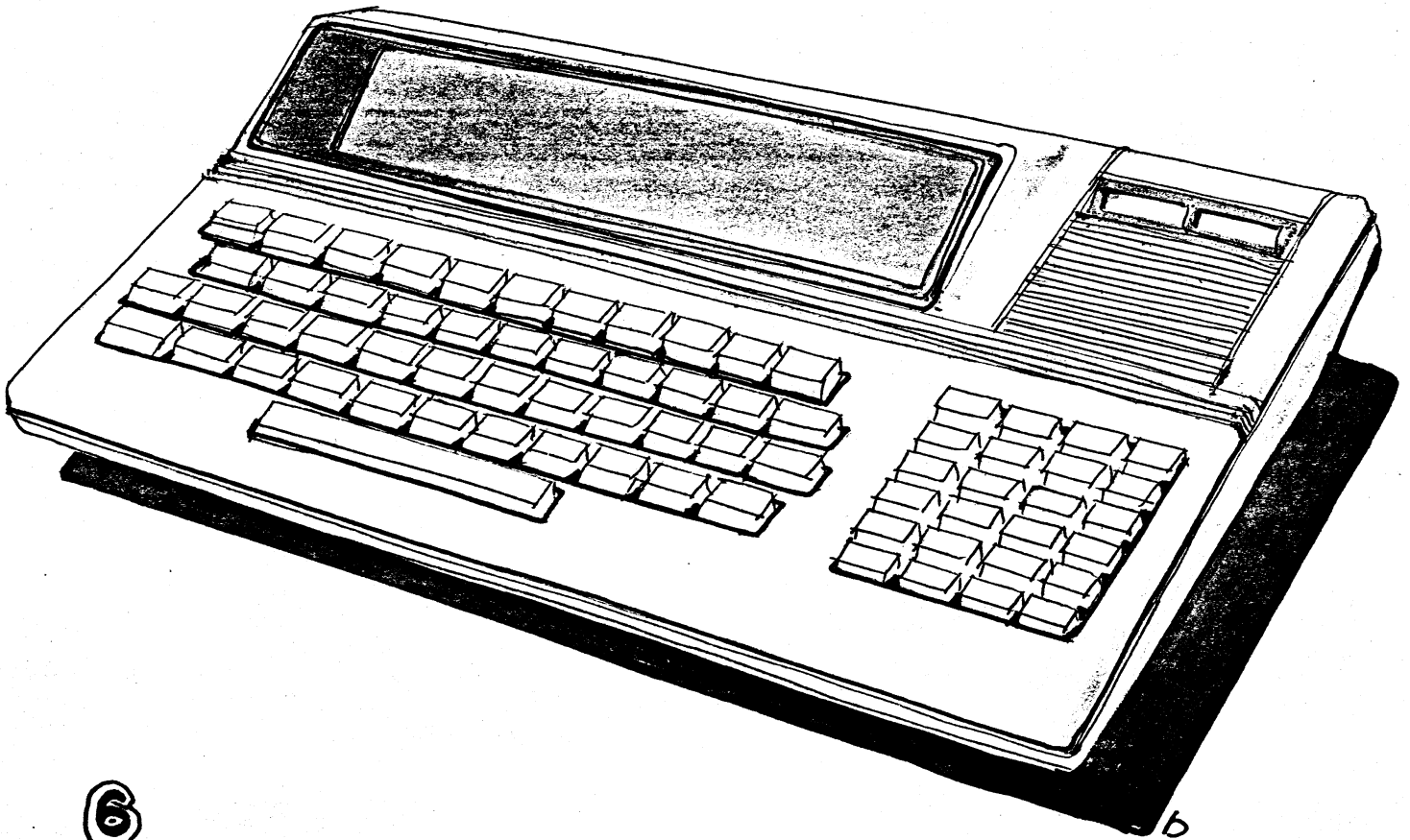

b

6

*Handwritten signature or text at the bottom right corner.*

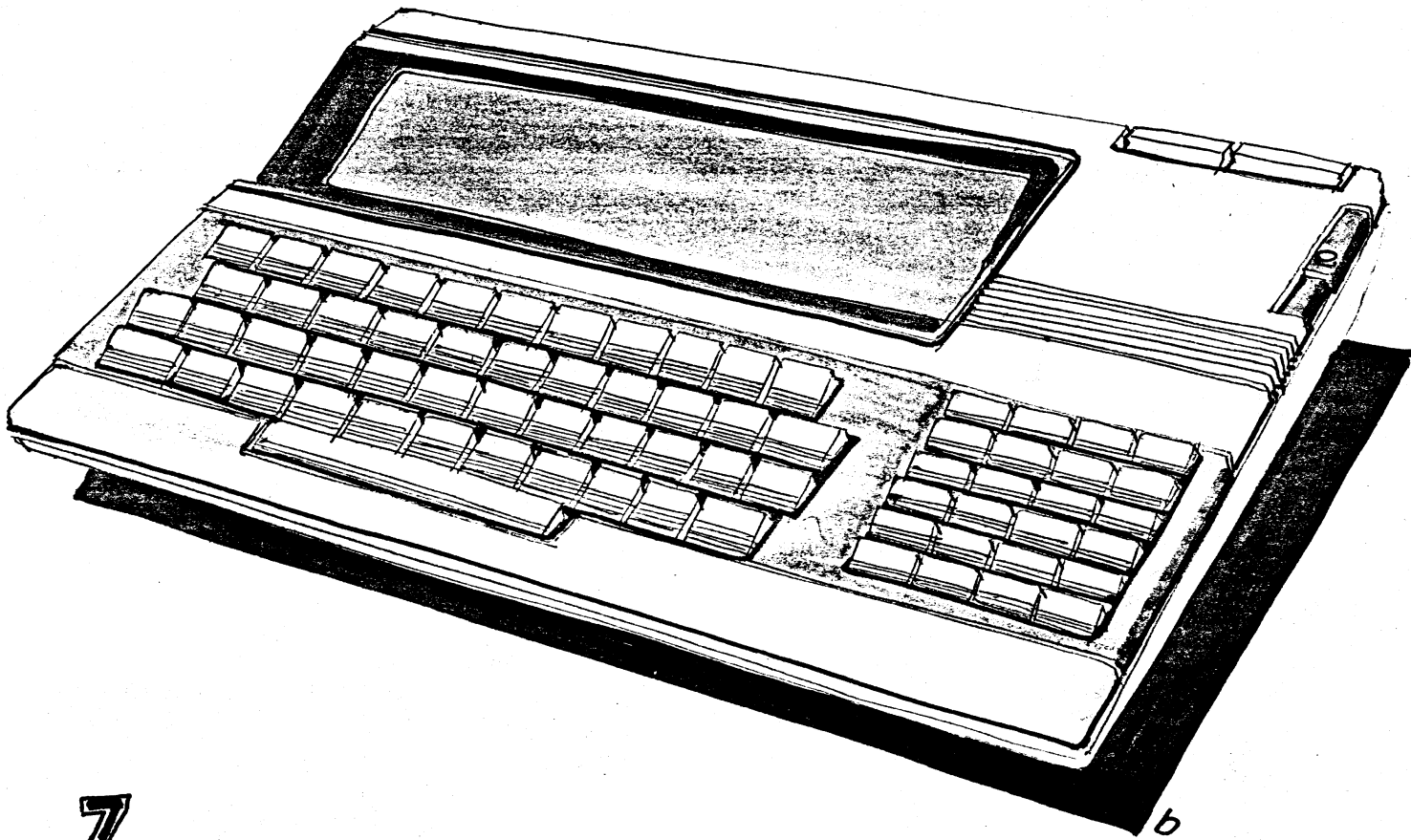
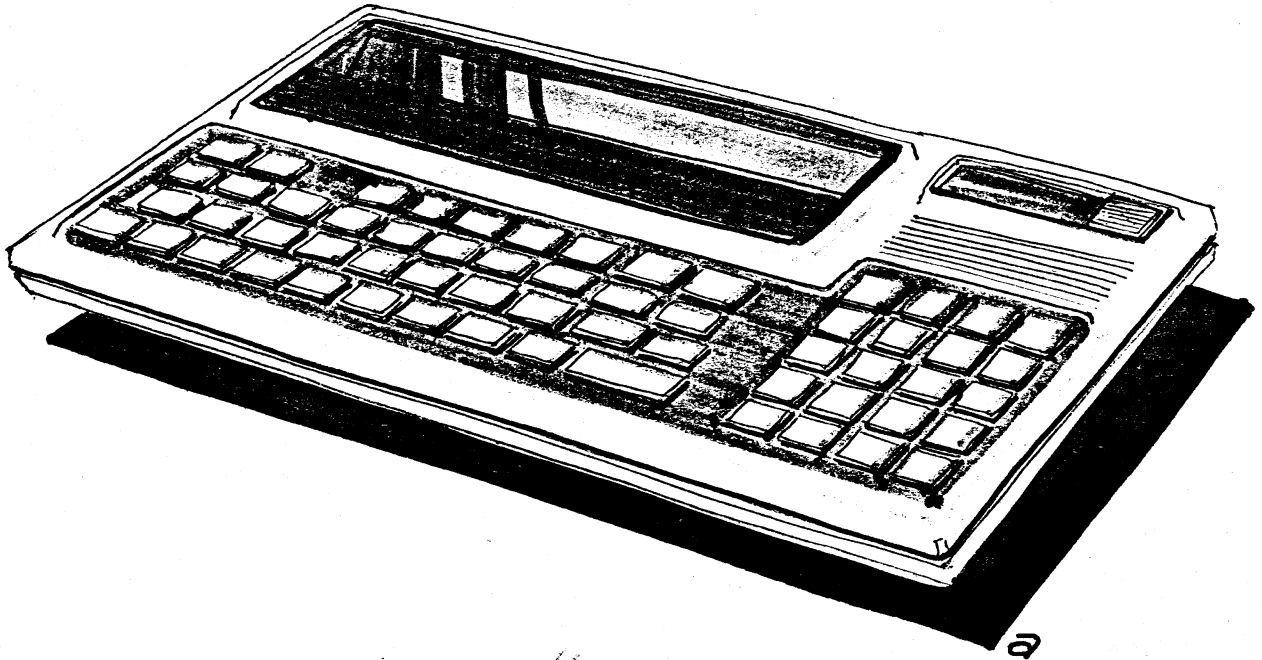

7

*Alfred... 3/21/82*



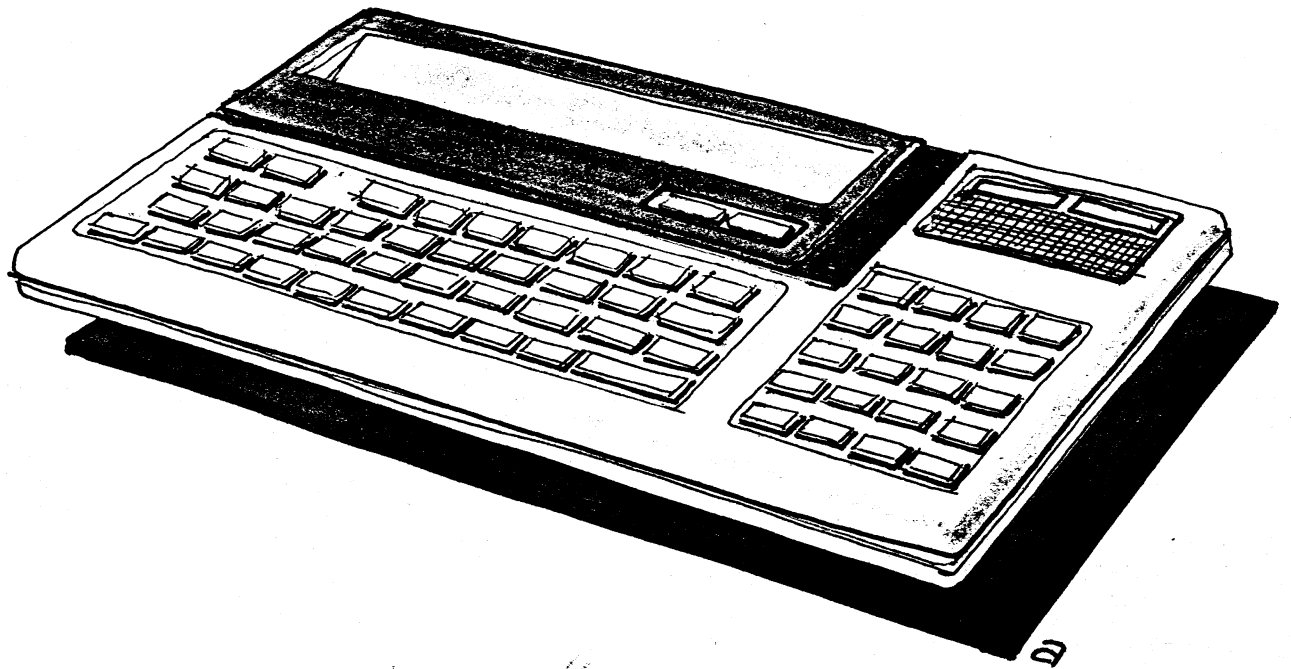

a

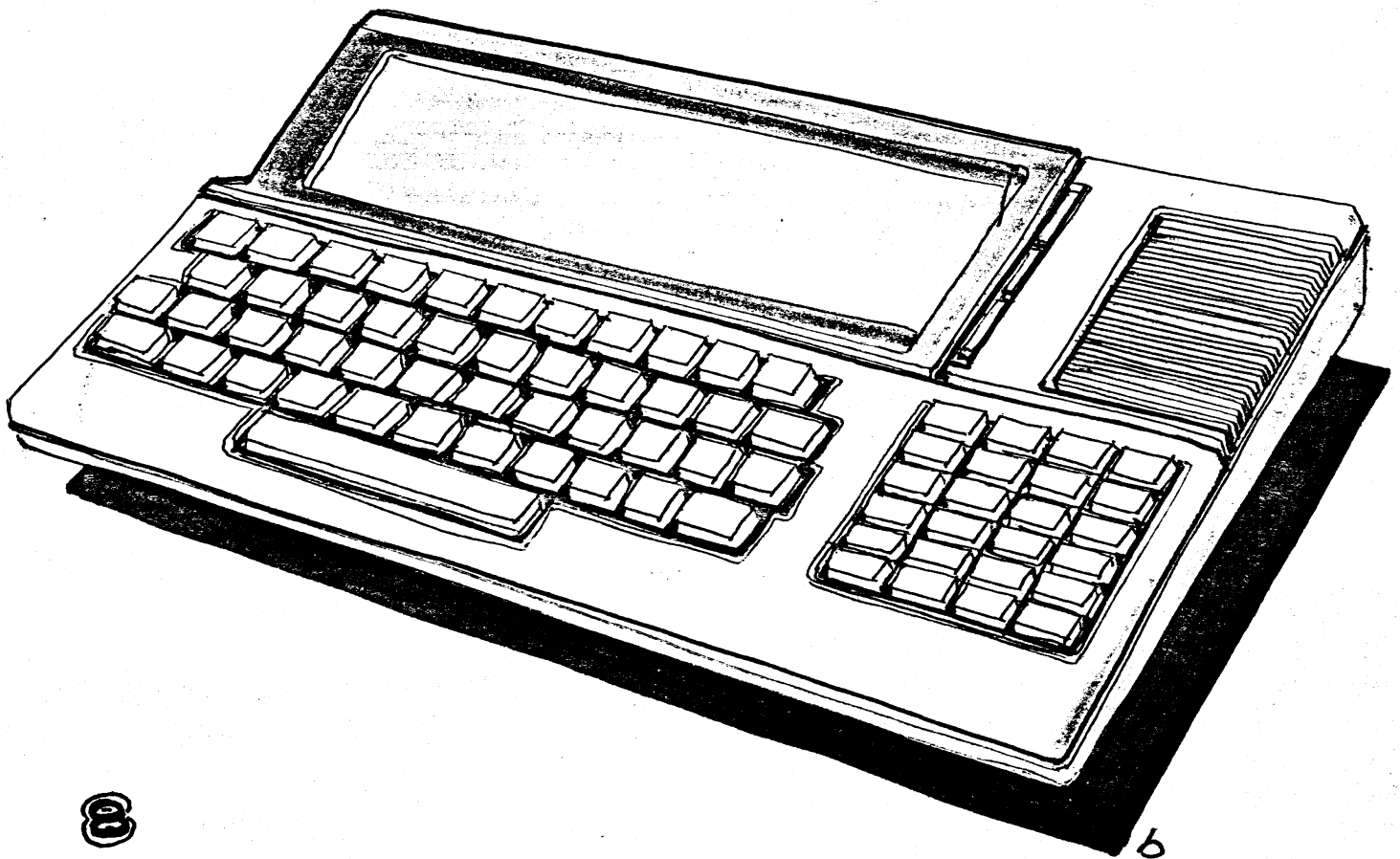

b

10

*Handwritten signature and date: 3/21/87*

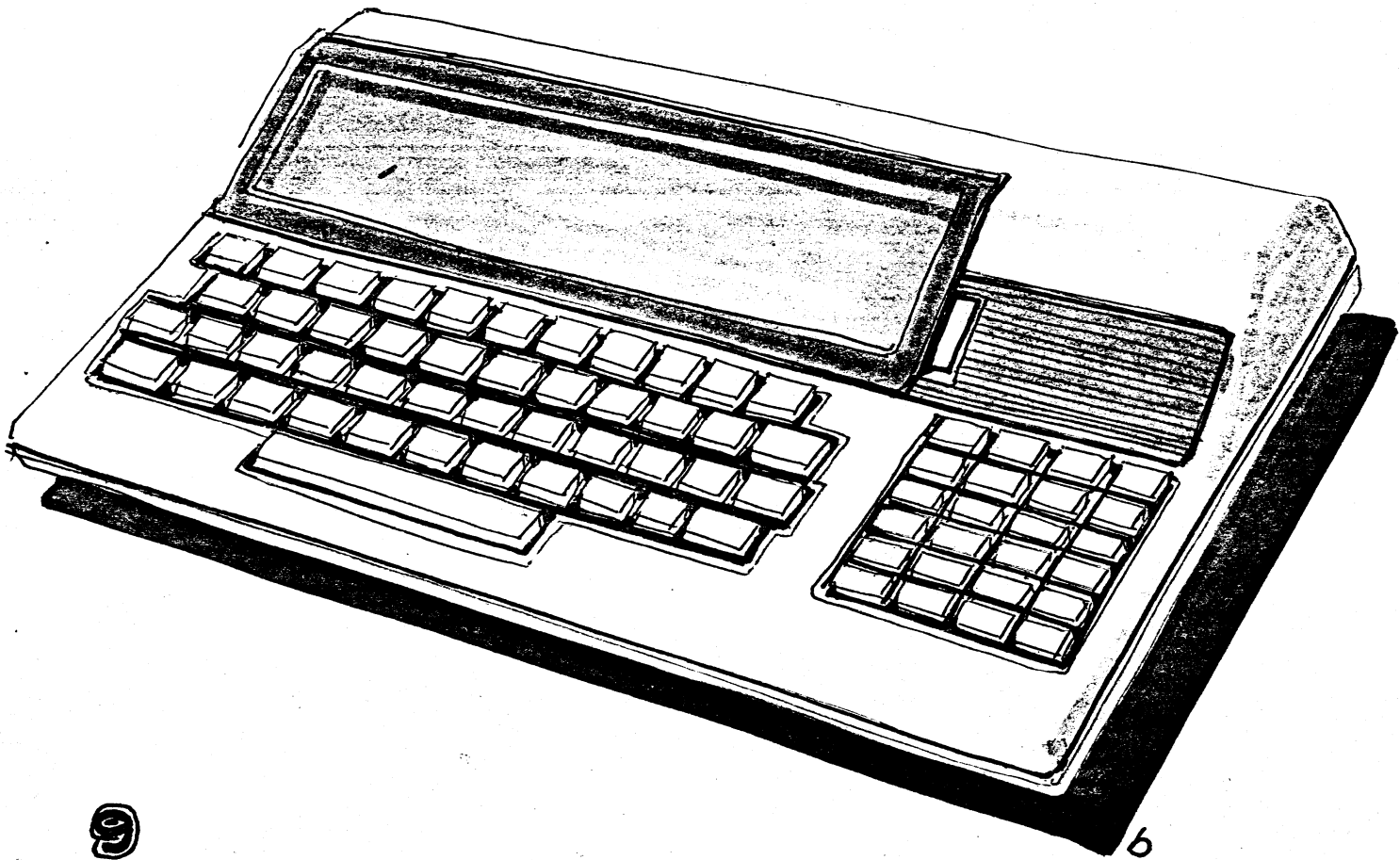
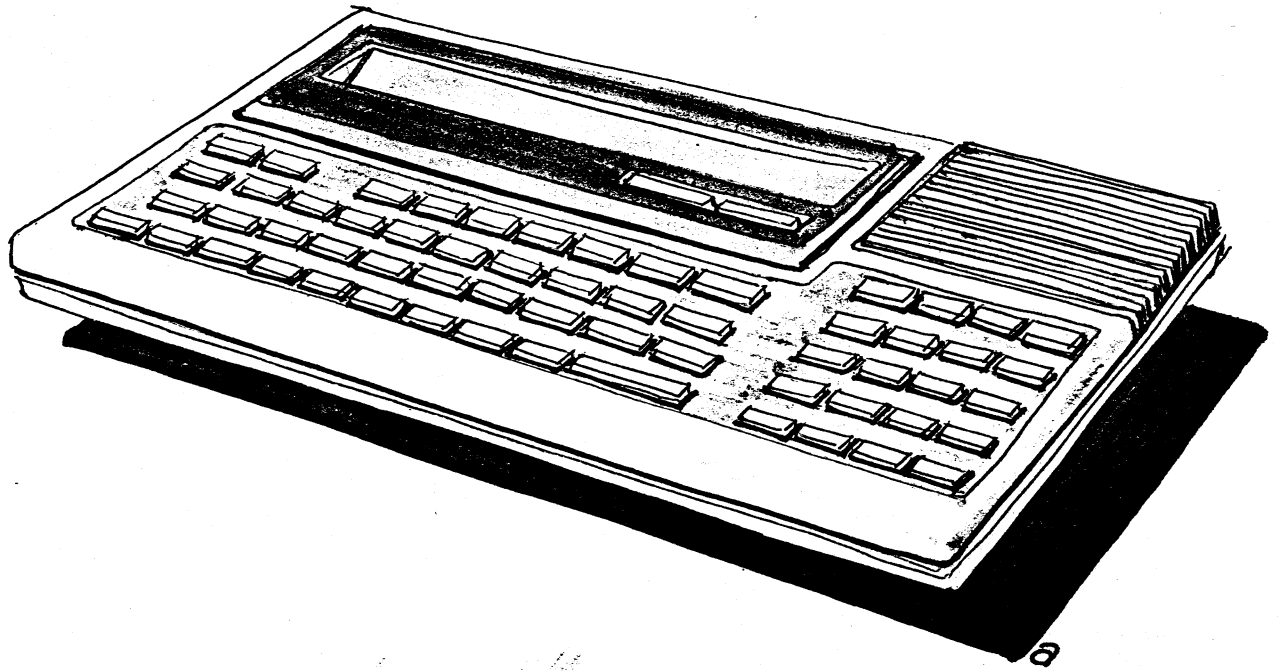

9

*Handwritten signature and date: 3/2/81*

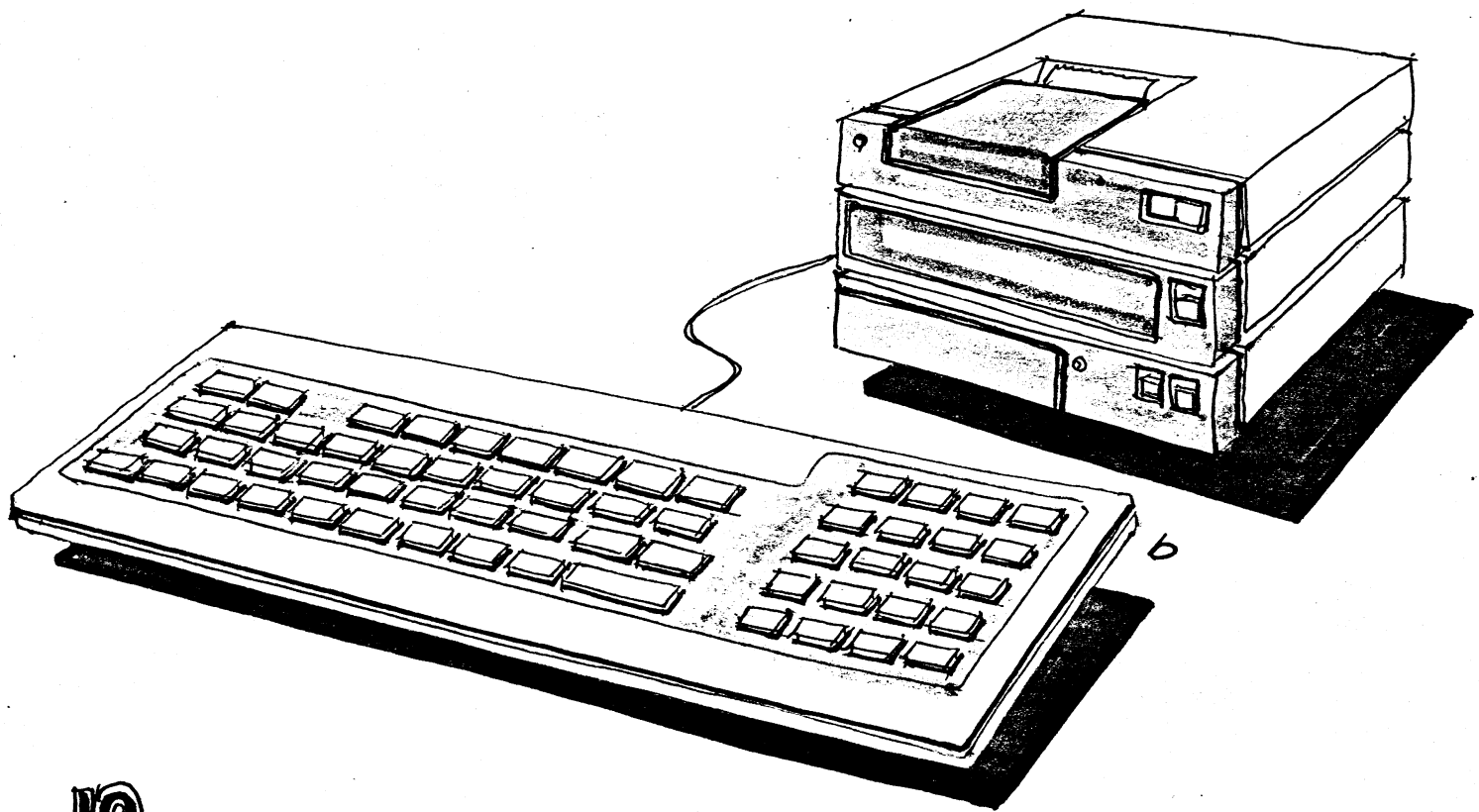
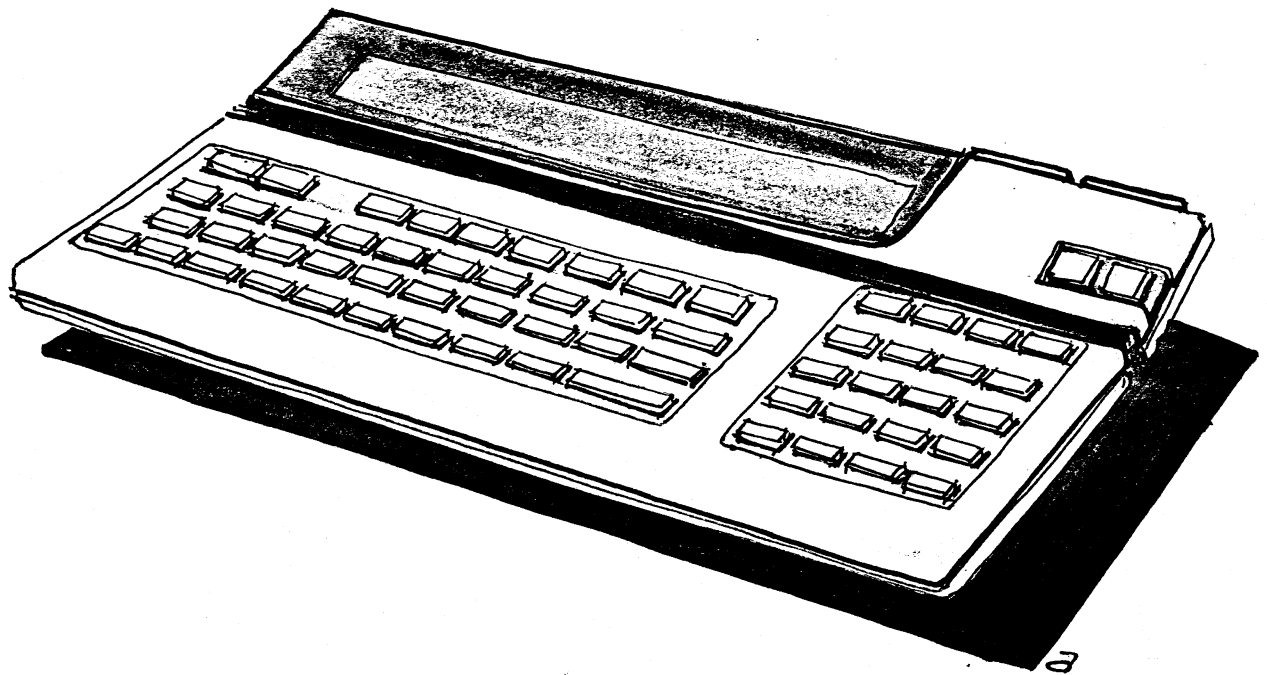

10

*Ellen ... 3/21/81*